

4640 Series Auto Equalizer

Features



The 4640 AUTO EQUALIZER™ is LCN's SMART & RELIABLE electrically powered low-energy power operator. It provides easy access for people with disabilities, or the elderly. Designed primarily for manual opening applications that occasionally require automatic opening.

Certifications	Grade 1 - ANSI A117.1, A156.19, UL 10C, ADA, 100 Hour Salt Spray, Meets BAA - Buy American Act	Cover	Metal, standard
Body Construction	<ul style="list-style-type: none"> Cast Iron Body Full Complement Bearing 1-1/2" Diameter Piston 3/4" Diameter Double Heat Treated Pinion Journal 	Fasteners	Wood and machine screws
Fluid	All Weather Fluid	Mounting	Top jamb (Push Side)
Handing	Non-Handed	Arms	<ul style="list-style-type: none"> Regular arm, standard Long arm, optional
Size	Adjustable Spring Size 2-5	Finishes/Colors/ Powder Coat	<ul style="list-style-type: none"> Aluminum (689) Statuary Bronze (690) Light Bronze (691) Black (693) Dark Bronze (695) Brass (696) Custom colors optional
Warranty	2 years		<ul style="list-style-type: none"> Optional SRI primer - powder coat only Optional plated finishes* <p>*End caps are black</p>

Special Templates

Customized installation templates or products may be available to solve unusual applications. Contact LCN Product Support for assistance.

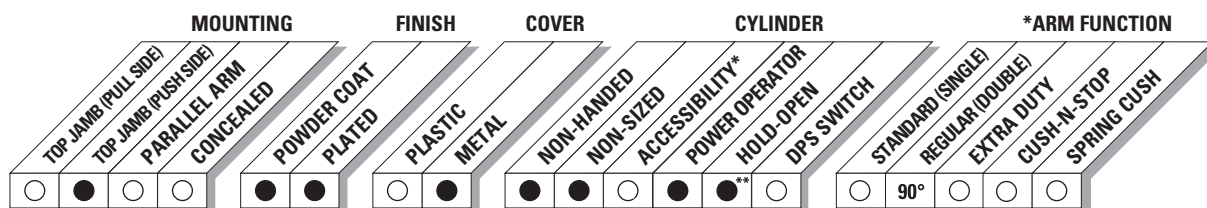

● AVAILABLE
○ NOT AVAILABLE

♿ Meets ADA requirements (power mode).
* See individual series for maximum manual opening.
** Switch provided for continuous hold open (4640 only).

4640 Series Auto Equalizer

Mounting details

Top Jamb (Push Side) Mounting

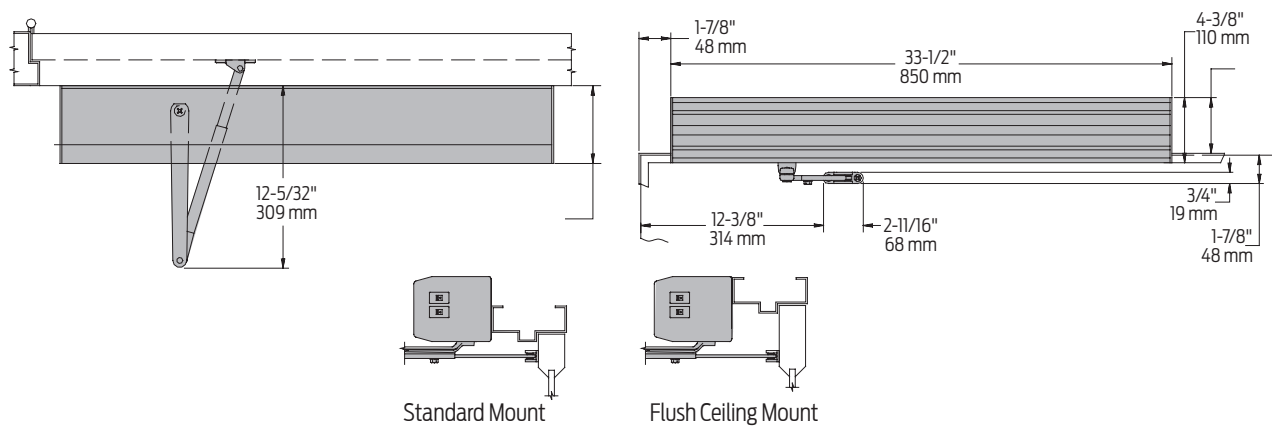

Butt Hinges	Should not exceed 5" (127 mm) in width
Auxiliary Stop	Recommended
Reveal	<ul style="list-style-type: none"> 4-1/2" (114 mm) allows up to 90° power opening and 100° manual opening 8" (203 mm) allows up to 90° power opening and 100° manual opening with LONG ARM where standard rod and shoe is replaced with optional LONG ROD AND SHOE, 4640-79LR
Head Frame	Minimum 1-3/4" (44 mm). The standard mounting plate is also used to meet flush ceiling conditions
Top Rail	<ul style="list-style-type: none"> Minimum 1-3/4" (44 mm) Flush ceiling installation requires 3-3/4" (95 mm) minimum
Opening Time and Force	<ul style="list-style-type: none"> Variable by adjustments to the electronic control module located on the operator assembly Maximum hold open time adjustable up to approximately five minutes
System Diagram	See "AUTOMATIC OPERATORS" section page 35 for typical system wiring and pages 37-38 for electrical data
Maximum Opening	<ul style="list-style-type: none"> Templating allows 90° power opening and 100° manual opening Consult factory for all pivot mounted installations

Notes:

- Actuators are sold separately, see pages 115-131
- Comes with a digital control box utilizing a 4040 heavy duty door closer with on-board diagnostics and power supply
- Has a factory default memory that include "No Destruct" drive system
- Guard rails or safety mats not required
- 4030 has easily accessible switches to provide on/off and continuous hold open functions
- CS options provides concealed on/off power switch
- Control module provides timing and sequential door functions, electric strike controls and adjustments for opening speed and force.

Cylinders



**4642-3971
Cast Iron Cylinder Assembly**

- Non-handed
- Standard

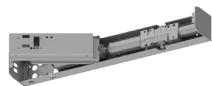

**4642-3071
Cast Iron Cylinder Assembly**

- Non-handed
- Mounting plate
- Includes; 4640-3454 Motor Clutch, 4640-3180 I/O Board Assembly and 4640-3462 Controller
- Standard

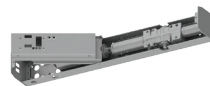

**4642-3071CS
Cast Iron Cylinder Assembly**

- Non-handed
- Mounting plate.
- Includes; 4640-3454 Motor Clutch, 4640-3180 I/O Board Assembly and 4640-3462 Controller
- Same as a 4640-3071 assembly except on/ off switch is concealed in endcap and no hold open switch is included. (Separate key switches suggested)
- Standard

Cover



**4640-72MC
Metal Cover**

- Non-handed
- Standard

Arms



**4640-3077
Regular Arm**

- Non-handed



**4640-3077L
Long Arm**

- Includes LONG ROD AND SHOE, 4640-79LR for deep reveals



**4640-79
Rod & Shoe**

- For use with regular arm



**4640-79LR
Long Rod & Shoe**

- Used for long arm with deep reveals

Installation Accessories



4640-334
Switch End Cap

- End cap (black powder finish coat only) with cut outs for installing on/off and hold open switches

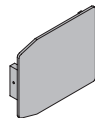

4640-334-2
Blank End Cap

- Black powder coat only



4640-334CS
Switch End Cap

- End cap and switch (black powder coat only) for concealed switch option



4640-3179-1
On/Off Switch Assembly

- Black rocker switch
- Plugs into high voltage PC board

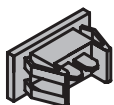

4640-3179-2
Hold Open Switch Assembly

- Black rocker switch
- field wired to low voltage PC board

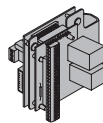

4640-3180
PC Board Assembly

- High and low voltage PC boards connected to mounting bracket



4640-3454
Motor/Clutch Assembly

- A geared assembly in an LCN power operator that incorporates a "no destruct" feature

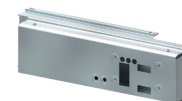

4640-3462
Control Box Assembly

- Digital controller with built-in 12/24 VDC power supply
- Programming and timing functions are adjusted on controller

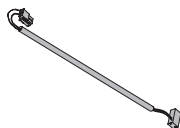

4640-3498-2
AC Power Cable

- 2 wire cable to connect 120 VAC from PC board assembly to controller



4640-3498-1
Ribbon Cable Connector

- 16 wire ribbon cable connecting 1-24 pin terminal connectors to controller